

## ***Table Of Contents***

Pictorial Index. . . . .	A-11	Applications & Dimensional Tolerances. . .	4-5
Introduction to High Temperature Ceramic Fiber Heaters. . . . .	4-2	Flat Panel Heaters . . . . .	4-6
Options & Accessories . . . . .	4-3	Full Cylindrical Heaters . . . . .	4-7
Properties & Performance. . . . .	4-4	Semi-Cylindrical Heaters . . . . .	4-8

**4**

**section**

# ***Ceramic Fiber Heaters***

# Ceramic Fiber Heaters



## Introduction

### High Temperature Ceramic Fiber Heaters



#### Design Features

- \* Standard Heaters to 1100°C (2012°F)
- \* High Temperature Version to 1200°C (2192°F)
- \* Low Thermally Conductive Built-In Insulation
- \* Standard Flat Panel, Full Cylindrical and Semicylindrical Shapes
- \* Fe-Cr-Al Alloy Resistance Wire Elements
- \* Standard 9" long double-twisted bare wire leads
- \* 100% Inorganic; free of Organics & Asbestos
- \* Thermal Shock Immunity
- \* Excellent Resistance to Chemical Attack

#### Industrial Uses

- | Industry        | Application  |
|-----------------|--|
| ↔ Aerospace     | ***** Crystal Growth, R & D                                    |
| ↔ Dental        | ***** Manufacture of Crowns and Bridges                        |
| ↔ Metals        | ***** Heat Treat and Temper                                    |
| ↔ Plastics      | ***** Sealers and Formers                                      |
| ↔ Automotive    | **** Metal Heat Treating and Paint Curing                      |
| ↔ Chemical      | ***** Remove By-Products & Catalyst Materials                  |
| ↔ Crystals      | ***** Preheat & Manufacturing of Optical and Gemstone Crystals |
| ↔ Glass         | ***** Annealing Process & Preheat of Glass Manufacturing       |
| ↔ Ceramic       | ***** Extrusion Dies   |
| ↔ Semiconductor | ** Diffusion Furnaces & Annealing Wafers                       |

#### Designed For High Temperatures and Efficiency

**Tempco Ceramic Fiber Insulated Heaters** combine a heat source with superior high temperature insulation—an ideal solution for an unlimited number of industrial heating applications. Tempco Ceramic Fiber Insulated Heaters produce fast, efficient, and reliable uniform heat to temperatures of 1100°C (2012°F). Higher temperature ratings, up to 1200°C (2192°F), are available with a limited number of designs.

#### Flat Panel, Full Cylindrical and Semi-Cylindrical Shaped Ceramic Fiber Insulated Heaters — Tempco Standard

These heaters are comprised of high-quality helically wound Fe-Cr-Al alloy resistance wire elements embedded in a rigid body of vacuum-formed high temperature refractory fiber. This ceramic fiber insulation has very low weight, thermal mass and thermal conductivity and thus can handle extremely rapid cycling.

The elements are typically mounted flush with the heated surface. The diameter of the helically wound element coil is kept to a minimum, reducing the difference between the element and chamber temperature, thus ensuring long heater life. This feature enables the design and manufacture of responsive heating systems and significantly reduces the risk of overheating the element.

- \* Standard 9" long double-twisted bare wire leads.
- \* Custom shapes are available on request.

All Tempco Ceramic Fiber Insulated Heaters are organic free and will not smoke or outgas.

#### MAXIMUM TEMPERATURE

The maximum temperature attainable is totally dependent on the application. To reach the maximum temperature stated, the application must be well insulated and sealed to trap the heat (like an oven) and allow the temperature to build. For example, to use a ceramic fiber cylindrical heater at its maximum temperature, the ends must be closed off with unheated insulated discs to minimize heat loss and allow the temperature to build.



### Ceramic Fiber Heater Features and Options

#### Construction Characteristics

Tempco's standard Ceramic Fiber Heaters are designed for a maximum temperature of 1100°C (2012°C). The resistance wire is wound in a helical coil and embedded flush to the heater surface.

Tempco's High Temperature Ceramic Fiber Heaters are designed for a maximum temperature of 1200°C (2192°F). The resistance ribbon wire is helically wound and mounted at the heater surface using a method that exposes three sides of the coil.

**The availability of High Temperature (1200°C) Ceramic Fiber Heaters is very limited. Consult Tempco with your requirements.**

#### Unheated Molded Ceramic Fiber Panels and Cylinders

Tempco can manufacture unheated ceramic fiber panels, full and semi-cylinders for applications that require additional insulation. For example, flat circles can be made to cover the top or bottom of a cylindrical shaped heater to produce a small furnace. The unheated insulation components are made from a similar material as the heaters, so the specifications are the same.

*To order, consult Tempco with your requirements.*

#### Thermowells

Quartz glass thermowell tubes can be inserted perpendicular to the heater, usually all the way through, for use with temperature probes to sense the interior temperature. The sensor probes are ordered separately. For a typical thermocouple sensor probe, see page 14-14, MTA1.

For .125" diameter sensor probes, specify a 4mm ID thermowell tube.  
For .187" diameter sensor probes, specify a 6mm ID thermowell tube.  
For .250" diameter sensor probes, specify an 8mm ID thermowell tube.

#### Optional Vestibules on Full and Semi-Cylindrical Heaters

Vestibules are used to support full or semi-cylindrical heaters around a pipe to heat the material flowing through the pipe. The vestibule is made from 1" ceramic fiber board cut to the correct OD and ID and then cemented to one or both ends of standard size full or semi-cylindrical heaters. The overall length for standard vestibules would be the original heater plus 2" for a vestibule on both ends or 1" for a vestibule on one end. It is recommended that for maximum temperatures, a vestibule width of 1.5" to 2" be specified.

**Full cylindrical heaters** with (two) vestibules are available with Type 1, 4, or 5 leads.

**Semi cylindrical heaters** with (two) vestibules are available with Type 1 or 3 leads.

*To order, consult Tempco with your requirements.*

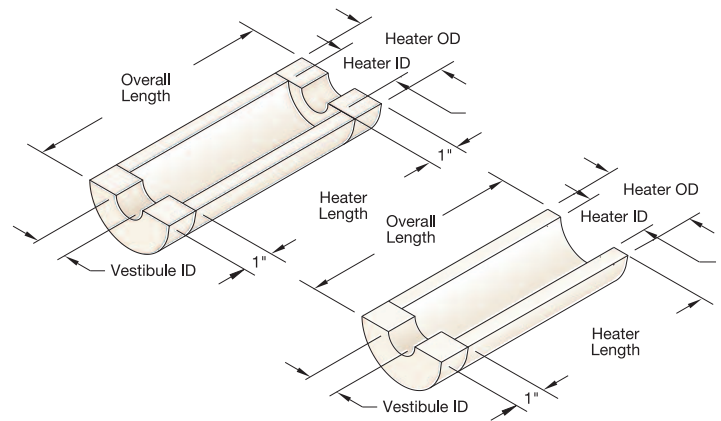

### Mounting / Repair Accessories

#### Rigidizer

The external surface of ceramic fiber heaters is treated with a chemical rigidizer to give the heater the hardened shell typical of this type of heater. When the ceramic heater is cut in the field prior to installation for any purpose, or repairs are required, rigidizer should be used to recoat the surface.

**Part Number:** CFR00010    **Quantity:** 1 Gal.

#### Ceramic Fiber Cement

The cement has many general purposes, such as bonding ceramic fiber heaters together or adding additional external insulation.

**Part Number:** CFR00020    **Quantity:** 1 Gal.

#### Ceramic Putty

Made from high purity Asbestos-Free Aluminum Oxide-based ceramics with a melting point in excess of 3200°F (1760°C) and formulated with special ceramic binders that, on drying, produce a strong ceramic body.

- ✓ **Resistant** to molten metals, most chemicals, oxidizing and reducing atmospheres.
- ✓ **Use for instant repairs** to brick, mortar, burner blocks, insulation furnace holders, thermocouples, etc.
- ✓ **Applications include** molding and bonding ceramic fiber components, high temp. insulation, insulation of pipes, supports, burners, turbines, etc.

**Size:** 4 oz. Squeeze Tube    **Part Number:** CFR00030

**Size:** 11 oz. Caulking Tube    **Part Number:** CFR00032

#### SPECIFICATIONS

<b>Melting Point</b> .....	3200°F (1760°C)
<b>Continuous Service</b> .....	2300°F (1260°C)
<b>Base Material</b> .....	Al <sub>2</sub> O <sub>3</sub>
<b>Density</b> .....	40-50 lbs./cu. ft.
<b>Specific Heat</b> .....	0.25 BTU/# °F
<b>Dielectric Constant</b> at 10 <sup>8</sup> cps .....	1.61
<b>Loss Factor</b> .....	0.017
<b>Dielectric Strength</b> .....	100 Volts/mm
<b>Thermal Conductivity</b> at 500°F (260°C) ...	0.65



## Properties & Performance

### Characteristics and Properties

#### Composition of Insulation

Al <sub>2</sub> O <sub>3</sub> (Alumina).....	38%
SiO <sub>2</sub> (Silica).....	62%
Organics .....	0%

**Bond**.....Silica

#### Bulk Density

gm/cm<sup>3</sup>, (lb/cu. ft.) 0.28 (18)

#### Thermal Conductivity

W/m <sup>2</sup> K (Btu/hr <sup>2</sup> F ft. <sup>2</sup> /in.)	
400°C (752°F).....	0.10 (0.8)
1100°C (2012°F) .....	0.22 (1.5)

#### Flexural Strength MPa (Psi)

As received .....	0.17 (25)
After 24 hrs. at 1000°C....	0.354 (51.34)

#### Compressive Strength MPa (Psi)

10% Deflection ..... 0.054 (7.83)

#### Stability—Linear Shrinkage

24 hrs. at temperature	
800°C (1472°F).....	0.3%
1000°C (1832°F) .....	1.8%
1200°C (2192°F) .....	2.5%

### Performance Characteristics

#### Performance of a Typical Round Ceramic Fiber Heater

The performance data represented in the chart was obtained by combining a Fiber Insulated Heater with 3" discs of insulation top and bottom. This assembly, which can be representative of many industrial and laboratory heating applications, was cycled with no load. Cool down rates were determined by turning the power off. Assembly was left intact. The “outside wall” temperature was measured on the external surface of the sidewall.

**Time vs. Temperature of a Typical Full Round High Temperature Ceramic Fiber Heater  
5.5" I.D. x 12" H x 11" O.D.**

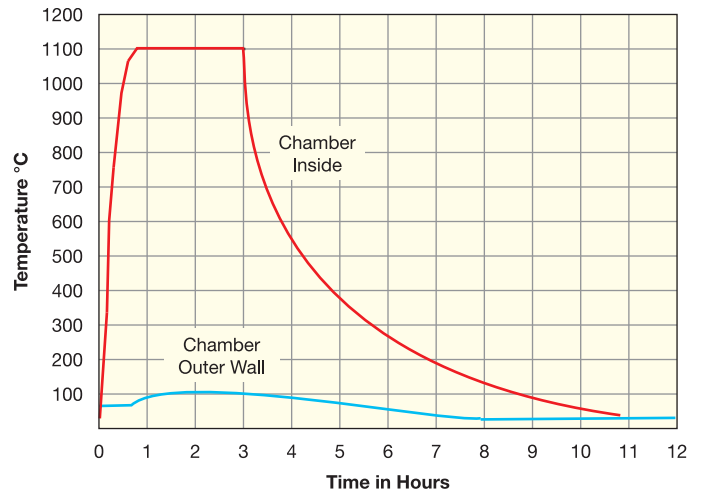

#### Performance of a Typical Rectangular Furnace

Test chamber left and right walls fabricated from Standard Fiber Insulated Heaters (24" x 36" x 5") and insulation boards. This size chamber, approximately 10 cubic feet, was chosen to best reflect performance characteristics of flat panel heaters as

used in a broad section of industrial applications. Chamber walls, roof and floor are 5" thick insulation. Cool down rate was plotted with data generated after element power was turned off. Chamber door remained closed. Chamber contained no load.

**Time vs. Temperature of an (approx.) 10 cubic foot furnace chamber incorporating Tempco's Ceramic Fiber Heaters.**

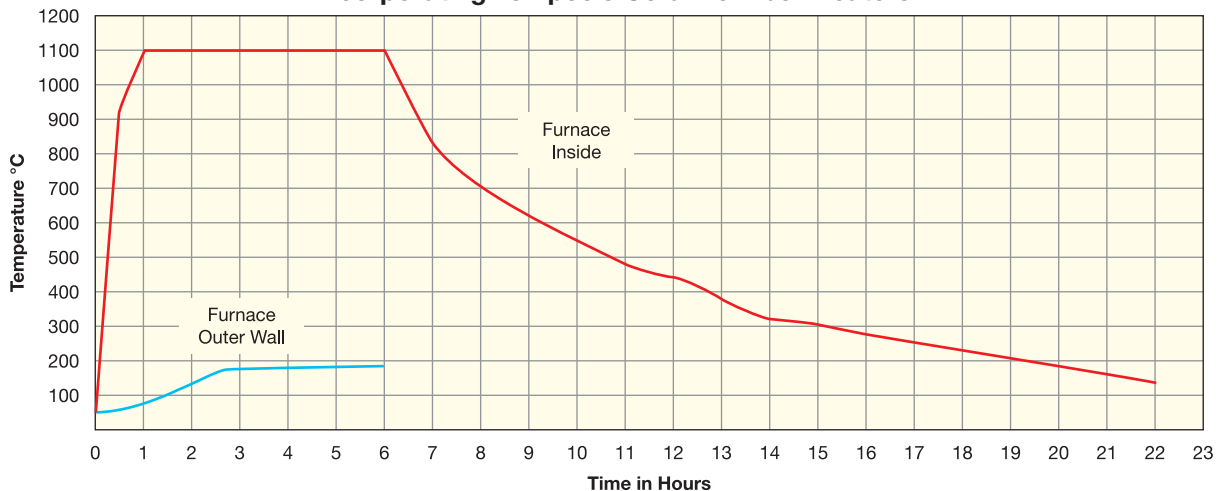



### Application Guidelines

1. High Temperature Ceramic Fiber heaters are *designed for radiant heat transfer* only. They are not intended for contact heating. They do not have the physical strength found in band, cartridge, strip or cast-in heaters.
2. *Mounting methods* such as washers, pins, screws, overlapping edge clamps, and interlocking edges work well with Ceramic Fiber heaters. Cementing is not recommended because it will not allow expansion or contraction.
3. The *maximum temperature attainable is totally dependent on the application*. To reach the maximum temperature stated, the application must be well sealed (like an oven) to trap the heat generated by the heater core and allow the temperature to build. If the heaters are used in an open environment the maximum temperatures will not be reached. For example, to use a ceramic fiber cylindrical heater at its maximum temperature, the ends must be closed off with un-heated insulated discs to minimize heat loss and allow the temperature to build.
4. Ceramic Fiber Heaters have a *very high porosity factor* and cannot be sealed against contamination and possible damage to the heating element. Keep the furnace free of contaminants that can vaporize at high temperatures.
5. The *temperature for most applications* needs to be controlled at a specific temperature. This can be most readily accomplished thru the use of fast responding electronic PID temperature controls. See Section 13 for single loop controls and Complete Control Systems.
6. *Thermocouple temperature probes* are used to sense the temperature of the application and provide feedback to the Temperature Control System. Typically, Type K thermocouples with an operating range up to 1260°C/2300°F are commonly used. Alloy 600 sheath material, good up to 1177°C/2150°F should be specified. Mineral insulated probes such as Tempco's MTA1 on catalog page 14-14 are highly recommended.
7. *Be careful with any electrical connections* made in the heated portion of the application. The connections must be rated for the expected operating temperature and current flow.
8. *Use only inorganic fibers and binders* to avoid corrosive fumes that could damage the heater.
9. Ceramic Fiber Heaters are easily damaged from *careless mechanical handling*, so handle the units and leads carefully.

### Dimensional Tolerances

#### Flat Panels

<b>Width:</b>	4", 6", 8"	± 1/8"
	10" through 32"	± 1/4"
<b>Length:</b>	6"	± 1/8"
	12" through 44"	± 1/4"
<b>Thickness:</b>	1"	± 1/8"
	2" through 4"	± 1/4"

#### Full Cylindrical

<b>I.D.:</b>	1.5" through 4"	± 1/8"
	5" through 18"	± 1/4"
<b>O.D.:</b>	3.5"	± 1/8"
	5" through 24"	± 1/4"
<b>Length:</b>	6"	± 1/8"
	12" and 18"	± 1/4"

#### Semi-Cylindrical

<b>I.D.:</b>	2" and 3.5"	± 1/8"
	5" through 18"	± 1/4"
<b>O.D.:</b>	6" through 22"	± 1/4"
	<b>Length:</b> 6"	± 1/8"
	12" through 36"	± 1/4"



**Standard Temperature (1100°C)  
Semi-Cylindrical Heater**

2" I.D. × 6" O.D. × 18" Long  
1130W, 240V



**High Temperature (1200°C)  
Flat Panel Heater**

12" Square × 2" Thick  
1100W, 120V



**High Temperature (1200°C)  
Semi-Cylindrical Heater**

7" I.D. × 11" O.D. × 12" Long  
1600W, 240V



**Note:** Temperature ratings of 1200°C (2192°F) are available on a limited number of designs. Consult Tempco.

# Ceramic Fiber Heaters



## Flat Panels

### Ceramic Fiber Flat Panel Heaters

#### Panel Styles

Type 1 Leads Shown

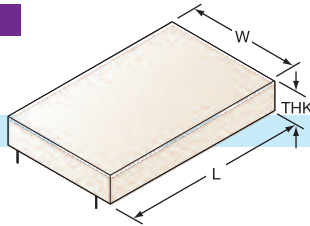

Style 1 — Entire Panel Heated

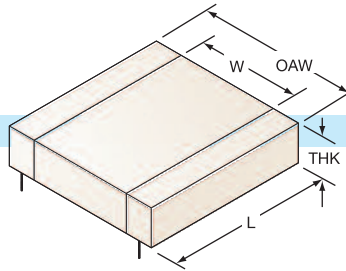

Style 2 — Unheated Ends in Width

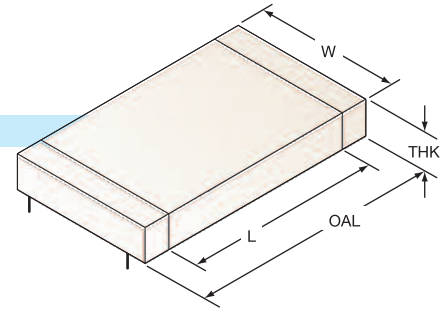

Style 3 — Unheated Ends in Length

#### Lead Locations

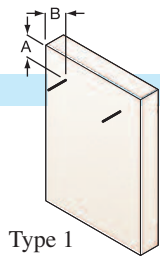

Type 1

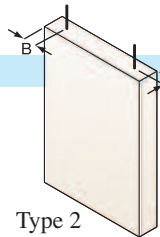

Type 2

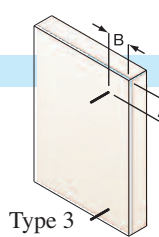

Type 3

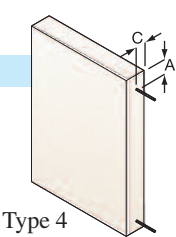

Type 4

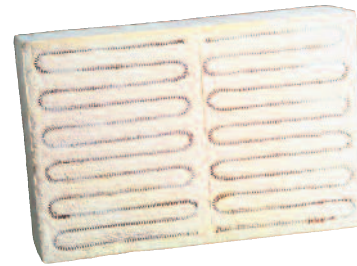

#### Standard Panel Heater

18" W ×  
24" L ×  
3" Thick

### Ordering Information

#### Standard Units

Select a **Flat Panel Heater** by size, electrical rating and style from the table below. To complete the part number, add the required lead location number.

#### For example

CFR1001□ has Type 2 Leads.

Standard leads are double twist 9" long high-temperature bare wire.

#### Custom Designed/Manufactured Flat Panel Heaters

Custom manufactured Flat Panel Ceramic Fiber Heaters are available; consult **Tempco** with your requirements. **Standard lead time is 4 weeks.**

**Please Specify** the following:

- 1100°C or 1200°C Construction Style
- Length
- Width
- Voltage and Wattage
- Lead Location and Type
- Special Features



**Note:** See page 4-2 for maximum temperature guidelines

### Standard (Non-Stock) Flat Panel High Temperature Ceramic Fiber Heaters (1100°C Construction Style)

All Dimensions are in inches. Lead Locations A, B and C are approximate. Complete the part number by adding the required lead location number.

Heated			Watts	Volts	Style 1			Style 2			Style 3							
W	L	Thk			Part Number	Lead Location			Part Number	OAW	Lead Location			Part Number	Lead Location			
						A	B	C				A	B	C				
4	6	1	250	60	CFR1001	1.0	1.0	0.5	CFR1019	6	1.0	2.0	0.5	CFR1037	8	2.0	1.0	0.5
4	12	1	500	60	CFR1002	1.0	1.0	0.5	CFR1020	6	1.0	2.0	0.5	CFR1038	14	2.0	1.0	0.5
6	6	2	375	60	CFR1003	1.5	1.5	1.0	CFR1021	10	1.5	3.5	1.0	CFR1039	10	3.5	1.5	1.0
6	12	2	750	120	CFR1004	1.5	1.5	1.0	CFR1022	10	1.5	3.5	1.0	CFR1040	16	3.5	1.5	1.0
6	18	2	1125	120	CFR1005	1.5	1.5	1.0	CFR1023	10	1.5	3.5	1.0	CFR1041	22	3.5	1.5	1.0
6	24	2	1500	120	CFR1006	1.5	1.5	1.0	CFR1024	10	1.5	3.5	1.0	CFR1042	28	3.5	1.5	1.0
8	12	2	1000	120	CFR1007	2.0	2.0	1.0	CFR1025	12	2.0	4.0	1.0	CFR1043	16	4.0	2.0	1.0
8	18	2	1500	120	CFR1008	2.0	2.0	1.0	CFR1026	12	2.0	4.0	1.0	CFR1044	22	4.0	2.0	1.0
8	24	2	2000	120	CFR1009	2.0	2.0	1.0	CFR1027	12	2.0	4.0	1.0	CFR1045	28	4.0	2.0	1.0
12	12	2	1500	120	CFR1010	2.0	2.0	1.0	CFR1028	16	2.0	4.0	1.0	CFR1046	16	4.0	2.0	1.0
12	18	2	2250	120	CFR1011	2.0	2.0	1.0	CFR1029	16	2.0	4.0	1.0	CFR1047	22	4.0	2.0	1.0
12	24	2	3000	240	CFR1012	2.0	2.0	1.0	CFR1030	16	2.0	4.0	1.0	CFR1048	28	4.0	2.0	1.0
12	36	2	4500	240	CFR1013	2.0	2.0	1.0	CFR1031	16	2.0	4.0	1.0	CFR1049	40	4.0	2.0	1.0
18	18	3	3375	240	CFR1014	2.5	2.5	1.5	CFR1032	24	2.5	5.5	1.5	CFR1050	24	5.5	2.5	1.5
18	24	3	4500	240	CFR1015	2.5	2.5	1.5	CFR1033	24	2.5	5.5	1.5	CFR1051	30	5.5	2.5	1.5
18	36	3	6750	480	CFR1016	2.5	2.5	1.5	CFR1034	24	2.5	5.5	1.5	CFR1052	42	5.5	2.5	1.5
24	24	4	6000	480	CFR1017	3.0	3.0	2.0	CFR1035	32	3.0	7.0	2.0	CFR1053	32	7.0	3.0	2.0
24	36	4	9000	480	CFR1018	3.0	3.0	2.0	CFR1036	32	3.0	7.0	2.0	CFR1054	44	7.0	3.0	2.0



### Ceramic Fiber Cylindrical Heaters

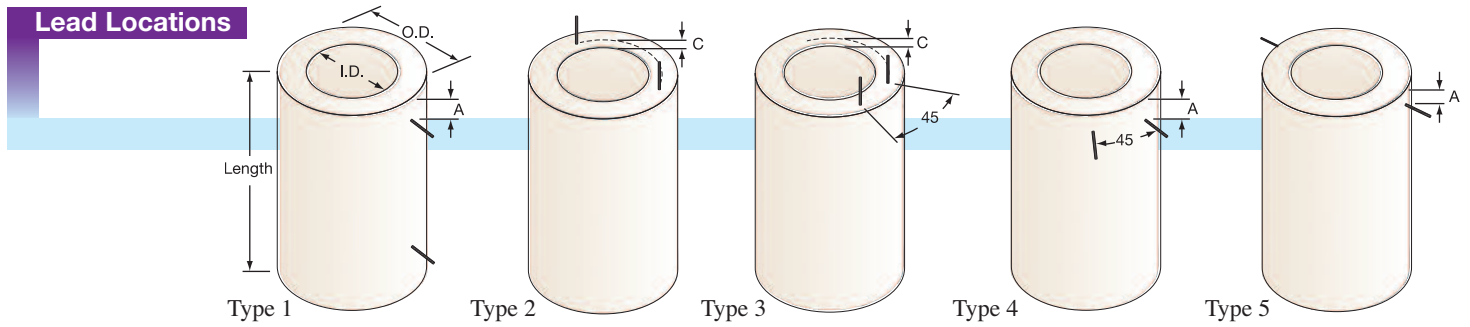

### Standard (Non-Stock) Full Cylindrical Shaped High-Temperature Ceramic Fiber Heaters (1100°C Construction Style)

All Dimensions are in inches. Lead Locations A and C are approximate. Complete the part number by adding the required lead location number.

I.D.	O.D.	Length	Watts	Volts	Lead Location		Part Number
					A	C	
1.5	3.5	12.0	600	120	1.5	0.5	CFR3004 <input type="checkbox"/>
2.0	5.0	6.0	400	60	1.0	0.8	CFR3005 <input type="checkbox"/>
2.0	5.0	12.0	800	120	1.5	0.8	CFR3006 <input type="checkbox"/>
3.0	6.0	6.0	600	120	1.0	0.8	CFR3007 <input type="checkbox"/>
3.0	6.0	12.0	1200	120	1.5	0.8	CFR3008 <input type="checkbox"/>
4.0	8.0	6.0	800	120	1.0	1.0	CFR3009 <input type="checkbox"/>
4.0	8.0	12.0	1600	120	1.5	1.0	CFR3010 <input type="checkbox"/>
5.0	9.0	6.0	1000	120	1.0	1.0	CFR3011 <input type="checkbox"/>
5.0	9.0	12.0	2000	120	1.5	1.0	CFR3012 <input type="checkbox"/>
6.0	10.0	6.0	1200	120	1.0	1.0	CFR3013 <input type="checkbox"/>
6.0	10.0	12.0	2400	120	1.5	1.0	CFR3014 <input type="checkbox"/>
6.0	10.0	18.0	3500	240	2.0	1.0	CFR3015 <input type="checkbox"/>
8.0	12.0	6.0	1600	120	1.0	1.0	CFR3016 <input type="checkbox"/>
8.0	12.0	12.0	3100	240	1.5	1.0	CFR3017 <input type="checkbox"/>
8.0	12.0	18.0	4700	240	2.0	1.0	CFR3018 <input type="checkbox"/>
10.0	16.0	6.0	2000	120	1.0	1.5	CFR3019 <input type="checkbox"/>
10.0	16.0	12.0	3900	240	1.5	1.5	CFR3020 <input type="checkbox"/>
10.0	16.0	18.0	5900	240	2.0	1.5	CFR3021 <input type="checkbox"/>
12.0	18.0	6.0	2400	120	1.0	1.5	CFR3022 <input type="checkbox"/>
12.0	18.0	12.0	4700	240	1.5	1.5	CFR3023 <input type="checkbox"/>
12.0	18.0	18.0	7100	240	2.0	1.5	CFR3024 <input type="checkbox"/>
14.0	20.0	12.0	5500	240	1.5	1.5	CFR3025 <input type="checkbox"/>
14.0	20.0	18.0	8200	240	2.0	1.5	CFR3026 <input type="checkbox"/>
16.0	24.0	12.0	6000	240	1.5	2.0	CFR3027 <input type="checkbox"/>
18.0	24.0	12.0	7100	240	1.5	2.0	CFR3028 <input type="checkbox"/>
18.0	24.0	18.0	10600	240	2.0	2.0	CFR3029 <input type="checkbox"/>



**Note:** See page 4-2 for maximum temperature guidelines



**Standard Full Cylindrical Shaped Heater**  
8" I.D. × 12" O.D. × 6" Long

### Ordering Information

#### Standard Units

Select a **Full Cylindrical Shaped Heater** by size and electrical rating from the table above. To complete the part number add the required lead location number.

#### For example

CFR3004  has Type 2 Leads.

Standard leads are double twist 9" long high-temperature bare wire.

#### Custom Designed/Manufactured Full Cylindrical Shaped Heaters

Custom manufactured Full Cylindrical Shaped Ceramic Fiber Heaters are available; consult **Tempco** with your requirements. **Standard lead time is 4 weeks.**

**Please Specify** the following:

- 1100°C or 1200°C Construction Style
- Length
- Inner Diameter
- Outer Diameter
- Wattage
- Voltage
- Lead Location and Type

# Ceramic Fiber Heaters



## Semi-Cylindrical Shapes

### Ceramic Fiber Semi-Cylindrical Heaters

#### Standard (Non-Stock) Semi-Cylindrical Shaped High-Temperature Ceramic Fiber Heaters (1100°C Construction Style)

All Dimensions are in inches. Lead Locations A, B and C are approximate. Complete the part number by adding the required lead location number.



**Note:** See page 4-2 for maximum temperature guidelines

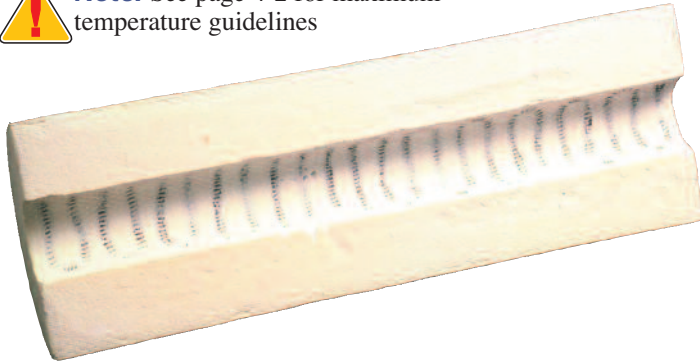

#### Standard Semi-Cylindrical Shaped Heater

2" I.D. x 6" O.D. x 18" Long

I.D.	O.D.	L	Watts	Volts	Lead Location			Part Number
					A	B	C	
2.0	6.0	6.0	200	60	1.0	1.0	1.0	CFR5003 <input type="checkbox"/>
2.0	6.0	12.0	400	120	1.5	1.0	1.0	CFR5004 <input type="checkbox"/>
2.0	6.0	18.0	600	120	2.0	1.0	1.0	CFR5005 <input type="checkbox"/>
2.0	6.0	24.0	800	240	2.0	1.0	1.0	CFR5006 <input type="checkbox"/>
3.5	7.5	6.0	350	60	1.0	1.5	1.0	CFR5007 <input type="checkbox"/>
3.5	7.5	12.0	700	120	1.5	1.5	1.0	CFR5008 <input type="checkbox"/>
3.5	7.5	18.0	1050	120	2.0	1.5	1.0	CFR5009 <input type="checkbox"/>
3.5	7.5	24.0	1400	240	2.0	1.5	1.0	CFR5010 <input type="checkbox"/>
5.0	9.0	6.0	500	60	1.0	1.5	1.0	CFR5011 <input type="checkbox"/>
5.0	9.0	12.0	1000	120	1.5	1.5	1.0	CFR5012 <input type="checkbox"/>
5.0	9.0	18.0	1500	240	2.0	1.5	1.0	CFR5013 <input type="checkbox"/>
5.0	9.0	24.0	2000	240	2.0	1.5	1.0	CFR5014 <input type="checkbox"/>
5.0	9.0	30.0	2500	240	2.5	1.5	1.0	CFR5015 <input type="checkbox"/>
5.0	9.0	36.0	3000	240	2.5	1.5	1.0	CFR5016 <input type="checkbox"/>
6.5	10.5	6.0	650	120	1.0	2.0	1.0	CFR5017 <input type="checkbox"/>
6.5	10.5	12.0	1300	240	1.5	2.0	1.0	CFR5018 <input type="checkbox"/>
6.5	10.5	18.0	1950	240	2.0	2.0	1.0	CFR5019 <input type="checkbox"/>
6.5	10.5	24.0	2600	240	2.0	2.0	1.0	CFR5020 <input type="checkbox"/>
6.5	10.5	30.0	3250	240	2.5	2.0	1.0	CFR5021 <input type="checkbox"/>
6.5	10.5	36.0	3900	240	2.5	2.0	1.0	CFR5022 <input type="checkbox"/>
8.0	12.0	12.0	1600	240	1.5	2.0	1.0	CFR5023 <input type="checkbox"/>
8.0	12.0	18.0	2400	240	2.0	2.0	1.0	CFR5024 <input type="checkbox"/>
8.0	12.0	24.0	3200	240	2.0	2.0	1.0	CFR5025 <input type="checkbox"/>
8.0	12.0	30.0	4000	240	2.5	2.0	1.0	CFR5026 <input type="checkbox"/>
8.0	12.0	36.0	4800	240	2.5	2.0	1.0	CFR5027 <input type="checkbox"/>
10.0	14.0	12.0	2000	240	1.5	2.0	1.0	CFR5028 <input type="checkbox"/>
10.0	14.0	18.0	3000	240	2.0	2.0	1.0	CFR5029 <input type="checkbox"/>
10.0	14.0	24.0	4000	240	2.0	2.0	1.0	CFR5030 <input type="checkbox"/>
10.0	14.0	30.0	5000	240	2.5	2.0	1.0	CFR5031 <input type="checkbox"/>
10.0	14.0	36.0	6000	240	2.5	2.0	1.0	CFR5032 <input type="checkbox"/>
12.0	16.0	12.0	2400	240	1.5	2.0	1.0	CFR5033 <input type="checkbox"/>
12.0	16.0	18.0	3600	240	2.0	2.0	1.0	CFR5034 <input type="checkbox"/>
12.0	16.0	24.0	4800	240	2.0	2.0	1.0	CFR5035 <input type="checkbox"/>
12.0	16.0	30.0	6000	240	2.5	2.0	1.0	CFR5036 <input type="checkbox"/>
12.0	16.0	36.0	7200	240	2.5	2.0	1.0	CFR5037 <input type="checkbox"/>
15.0	19.0	12.0	3000	240	1.5	2.0	1.0	CFR5038 <input type="checkbox"/>
15.0	19.0	18.0	4500	240	2.0	2.0	1.0	CFR5039 <input type="checkbox"/>
15.0	19.0	24.0	6000	240	2.0	2.0	1.0	CFR5040 <input type="checkbox"/>
15.0	19.0	30.0	7500	240	2.5	2.0	1.0	CFR5041 <input type="checkbox"/>
15.0	19.0	36.0	9000	240	2.5	2.0	1.0	CFR5042 <input type="checkbox"/>
18.0	22.0	12.0	3600	240	1.5	2.0	1.0	CFR5043 <input type="checkbox"/>
18.0	22.0	18.0	5400	240	2.0	2.0	1.0	CFR5044 <input type="checkbox"/>
18.0	22.0	24.0	7200	240	2.0	2.0	1.0	CFR5045 <input type="checkbox"/>

#### Lead Locations

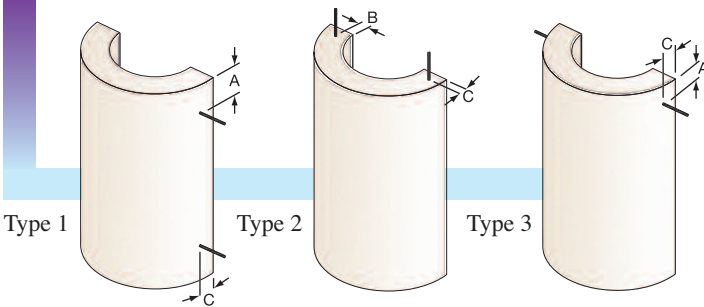

**Note:** Semi-Cylindrical Heaters are produced individually, but made to fit together in a full circle without a gap.

#### Ordering Information

##### Standard Units

Select a **Semi-Cylindrical Shaped Heater** by size and electrical rating from the table above. To complete the part number add the required lead location type by number.

##### For example

CFR5003  has Type 2 Leads.

Standard leads are double twist 9" long high-temperature bare wire.

##### Custom Designed/Manufactured Semi-Cylindrical Shaped Heaters

Custom manufactured Semi-Cylindrical Shaped Ceramic Fiber Heaters are available; consult **Tempco** with your requirements.

**Standard lead time is 4 weeks.**

**Please Specify** the following:

- 1100°C or 1200°C Construction Style
- Length
- Inner Diameter
- Outer Diameter
- Wattage
- Voltage
- Lead Location and Type